



**Wichtig!** Bitte mit der Pflegeanleitung aufbewahren!

**Important!** Please keep together with care instructions!

**Let op!** Bewaren samen met de onderhoudsinstructies!

**Important!** Conservare ensemble avec les conseils d'entretien!

**Importante!** Conservare con le istruzioni per la manutenzione!

**Важное указание!** Просьба хранить вместе с руководством по уходу!

# Cosiflor VS 2

Bitte nur beiliegende Schrauben verwenden.

Please use enclosed screws only.

Gelieve enkel bijgevoegde schroeven te gebruiken.

Se servir exclusivement des vis jointes.

Si prega di utilizzare solo le viti allegate.

Просьба использовать только приложенные винты.



## Montage • Fitting • Montage • Montaggio • Монтаж

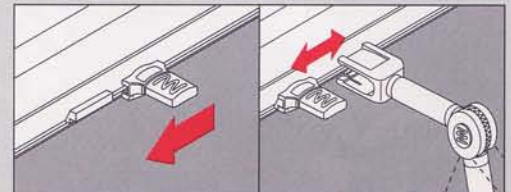
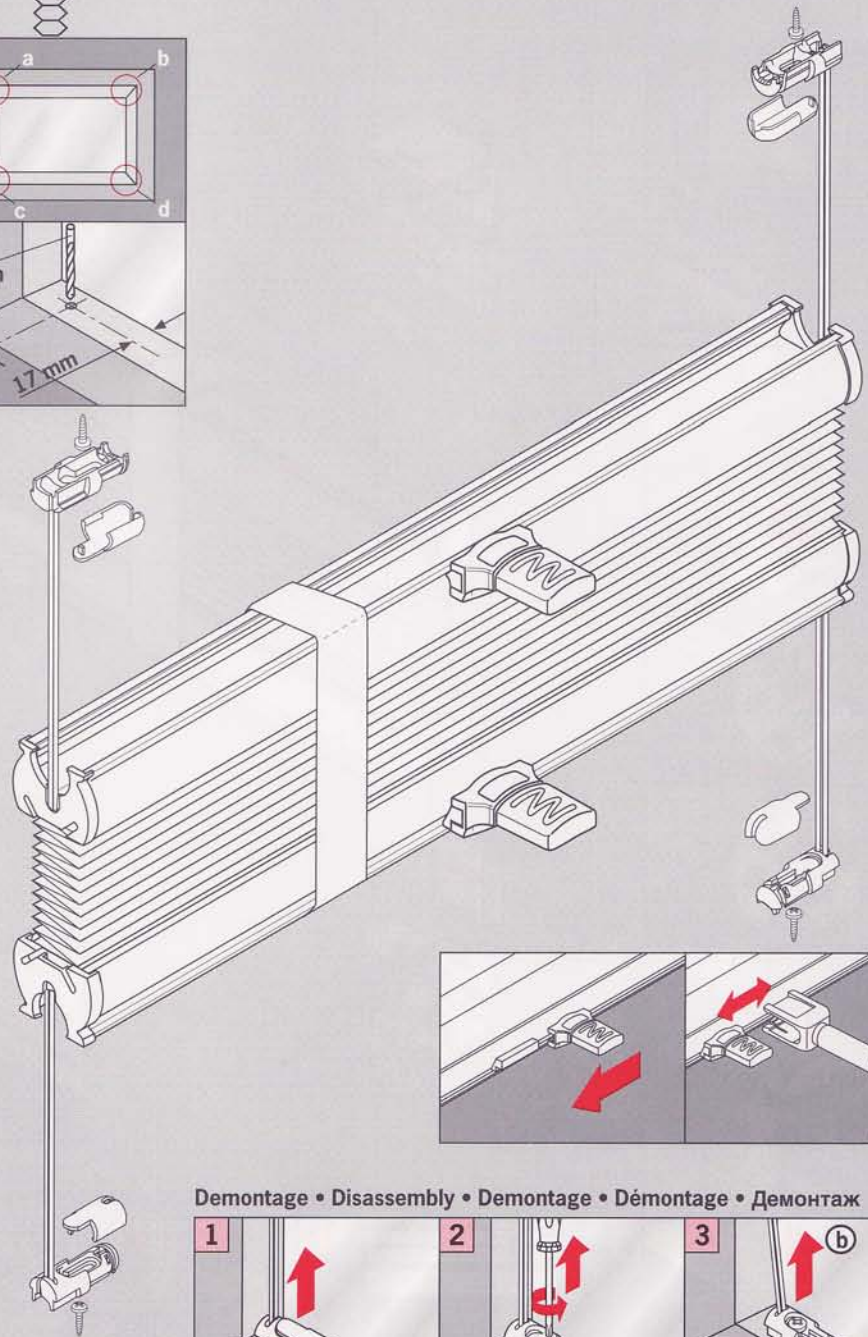
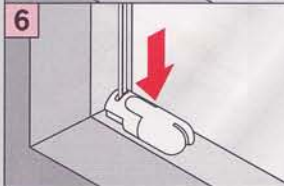
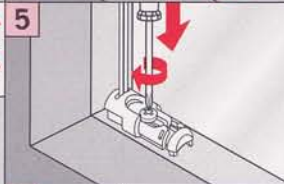
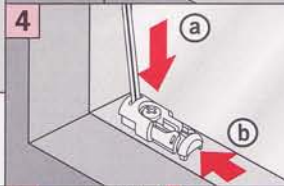
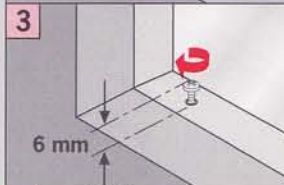
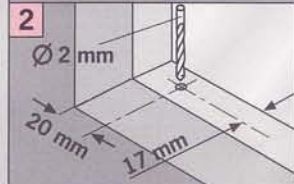
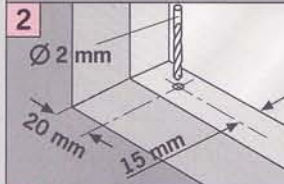
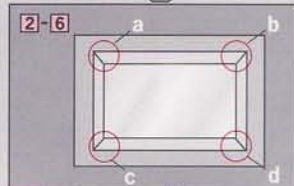
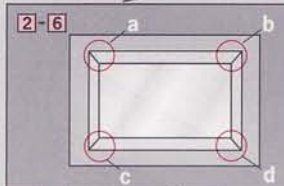
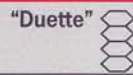
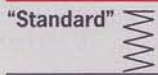
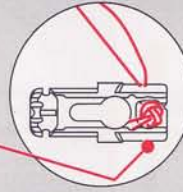

## Demontage • Disassembly • Demontage • Démontage • Демонтаж

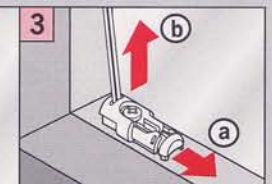
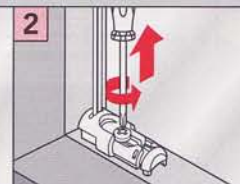
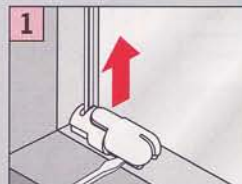



**Wichtig!** Bitte mit der Pflegeanleitung aufbewahren!  
**Important!** Please keep together with care instructions!  
**Let op!** Bewaren samen met de onderhoudsinstructies!  
**Important!** Conserver ensemble avec les conseils d'entretien!  
**Importante!** Conservare con le istruzioni per la manutenzione!  
**Важное указание!** Просьба хранить вместе с руководством по уходу!

# Cosiflor VS 2

Bitte nur beiliegende Schrauben verwenden.  
 Please use enclosed screws only.  
 Gelieve enkel bijgevoegde schroeven te gebruiken.  
 Se servir esclusivamente des vis jointes.  
 Si prega di utilizzare solo le viti allegate.  
 Просьба использовать только приложенные винты.

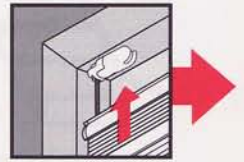

## Montage • Fitting • Montage • Montaggio • Монтаж

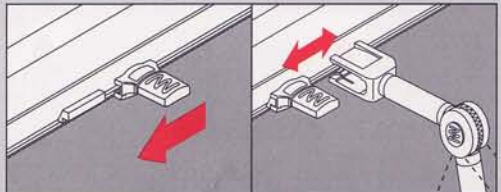
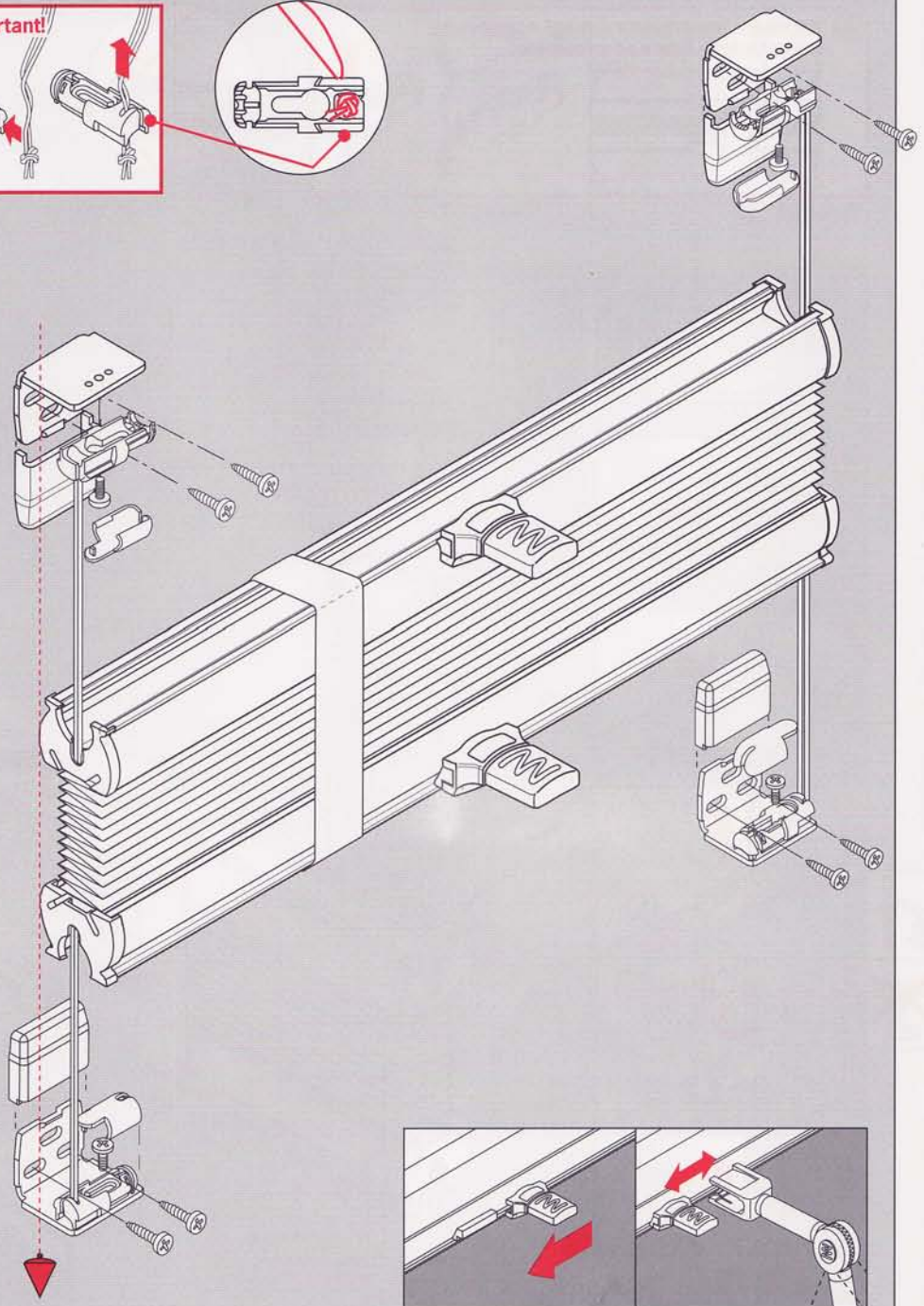
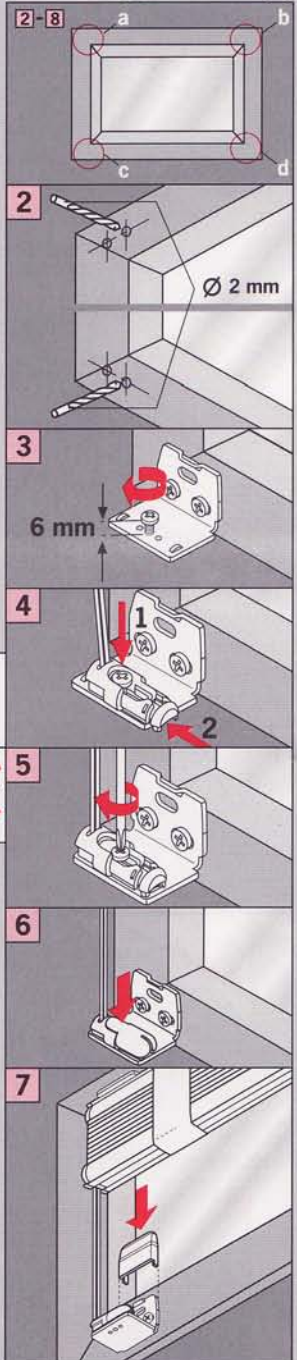
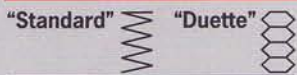

## Demontage • Disassembly • Demontage • Démontage • Демонтаж

