

TYP 3.6 PLAFOND VARIO

Rollobreite: 400 cm (siehe Stoffeigenschaften)
 Anlagenhöhe: 650 cm (siehe Stoffeigenschaften),
bis 18 m auf Anfrage
 Profilfarben: weiß (RAL 9016)
 weitere Farben auf Anfrage
 Tuchstütze: ab 300 cm Ausladung erforderlich

Wir empfehlen als Behang:

- formstabile und reißfeste Gewebe

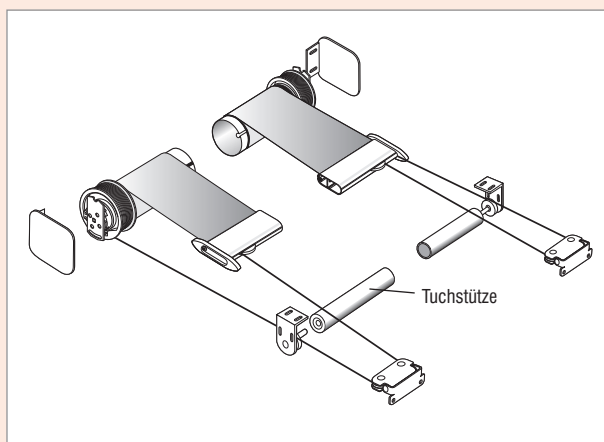

Standardbedienung
230 V Motor

MONTAGE

Wand (Universalträger)

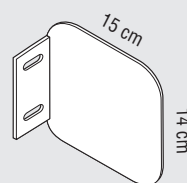

Decke (Universalträger)

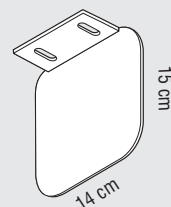

FAHRRICHTUNG

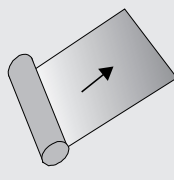
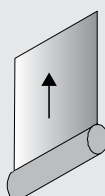
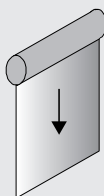

schräg

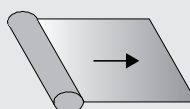

waagrecht

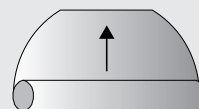

halbrund

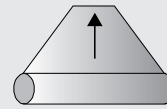

asymmetrisch

TYP 3.6

