





# TYP 5.10 ZIP

Anw.-bereich: **innen / außen**  
 Rollobreite: max. 600 cm (s. Stoffeigenschaften)  
 Anlagenhöhe: **max. 600 cm** (s. Stoffeigenschaften)  
 Ausführung: Kassettensystem  
 Einsatzort: Sonnenschutz, Sichtschutz, Hitzeschutz, Blendschutz, Verdunkelung, Dekoration (behangabhängig)  
 Seitenführung: Profil-Führungsschiene  
 Profilarben: weiß (RAL 9016), altweiß (RAL9010), cremeweiß (RAL 9001) weißaluminium (RAL 9006), silbergrau (RAL 9007), anthrazit (RAL 7016), anthrazit struktur (RAL 7016), optional: weitere RAL-Farben (auf Anfrage)

Bedienung:       
 Kurbel  
optional: 24 V Motor, 230 V Motor (gegen Mehrpreis)  
 Gewebe: **siehe Textilscreens-Stoffkarte (nur SOLTIS 86/92)**

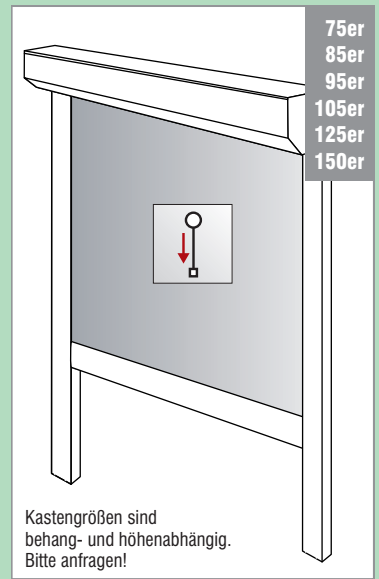
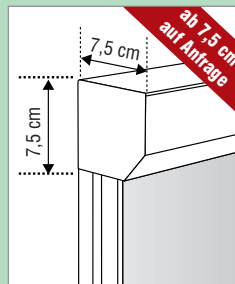
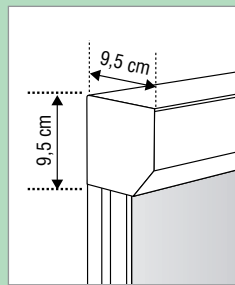

**ZIP-Rollos als:  
 Innenrollos | Verdunkelungsanlagen  
 Filmleinwände | Werbeträger  
 Fassadenmarkisen | Insektenschutz  
 Wetterschutz**

## MONTAGE

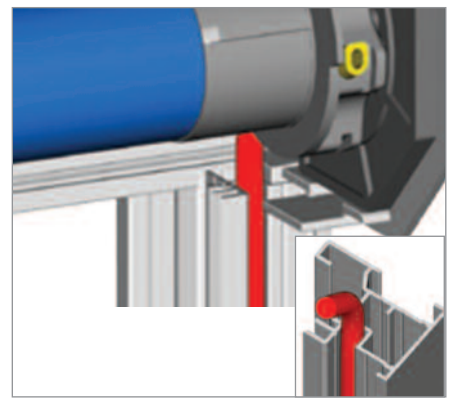
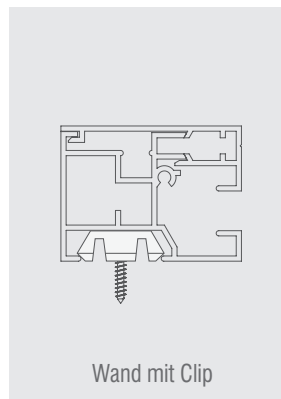
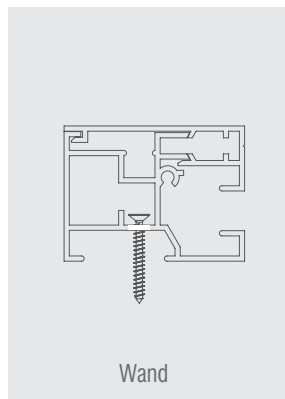
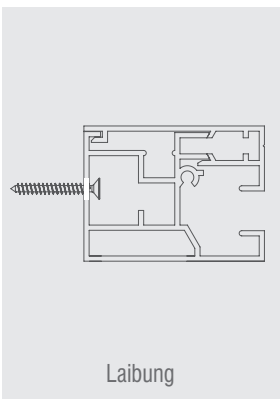

## SEITENFÜHRUNG - Führungsschienen

Aufpreise siehe Preisliste

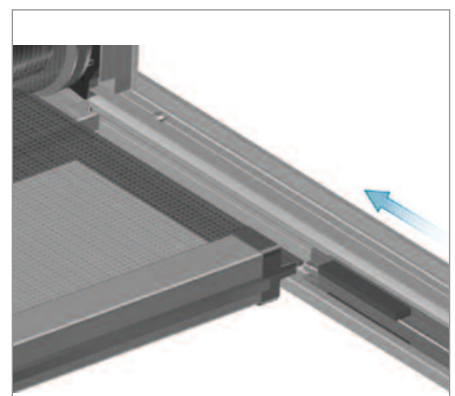
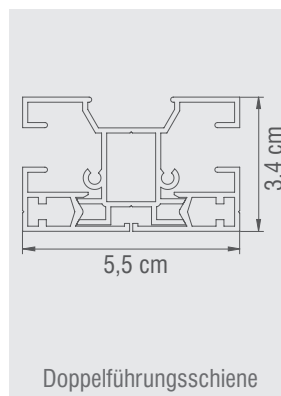
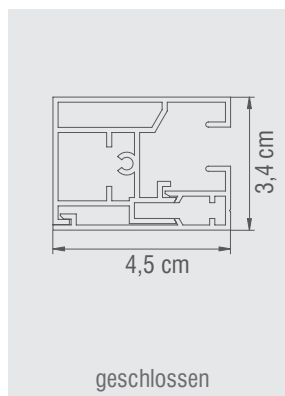
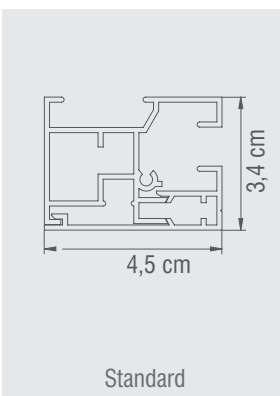

## TYP 5.10 ZIP

### FALLPROFILE (Querschnitte)

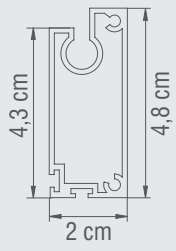

Standard

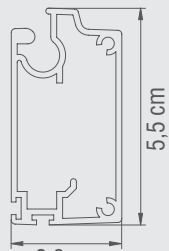

2,8 cm  
verstärkt

### IDECKENINTEGRIERT



# TYP 5.10 ZIP 95er Kasette

(Gewebe: SOLTIS 86/92 | Bedienung: Kurbel)

VK-Preise in €

Höhe cm	Breite									
	80 cm	90 cm	100 cm	110 cm	120 cm	130 cm	140 cm	150 cm	160 cm	170 cm
80	687	703	720	736	753	770	786	803	819	836
90	700	717	734	751	768	785	802	819	836	854
100	712	730	748	765	783	801	818	836	854	871
110	725	743	762	780	798	816	835	853	871	889
120	738	757	776	794	813	832	851	870	888	907
130	751	770	789	809	828	848	867	886	906	925
140	763	783	803	823	843	863	883	903	923	943
150	776	797	817	838	858	879	899	920	940	961
160	789	810	831	852	873	894	916	937	958	979
170	802	823	845	867	888	910	932	953	975	997
180	815	837	859	881	903	926	948	970	992	1015
190	827	850	873	896	919	941	964	987	1010	1033
200	840	863	887	910	934	957	980	1004	1027	1050
210	853	877	901	925	949	973	997	1020	1044	1068
220	866	890	915	939	964	988	1013	1037	1062	1086
230	878	904	929	954	979	1004	1029	1054	1079	1104
240	891	917	943	968	994	1019	1045	1071	1096	1122
250	904	930	956	983	1009	1035	1061	1087	1114	1140
260	917	944	970	997	1024	1051	1077	1104	1131	1158
270	930	957	984	1012	1039	1066	1094	1121	1148	1176
280	942	970	998	1026	1054	1082	1110	1138	1166	1194
290	955	984	1012	1041	1069	1098	1126	1155	1183	1211
300	968	997	1026	1055	1084	1113	1142	1171	1200	1229

Höhe cm	Breite									
	180 cm	190 cm	200 cm	210 cm	220 cm	230 cm	240 cm	250 cm	260 cm	
80	852	869	885	902	918	935	951	968	985	
90	871	888	905	922	939	956	973	990	1008	
100	889	907	925	942	960	978	995	1013	1031	
110	908	926	944	962	981	999	1017	1035	1054	
120	926	945	964	983	1001	1020	1039	1058	1077	
130	945	964	983	1003	1022	1041	1061	1080	1100	
140	963	983	1003	1023	1043	1063	1083	1103	1123	
150	981	1002	1023	1043	1064	1084	1105	1125	1146	
160	1000	1021	1042	1063	1084	1105	1126	1148	1169	
170	1018	1040	1062	1083	1105	1127	1148	1170	1192	
180	1037	1059	1081	1104	1126	1148	1170	1192	1215	
190	1055	1078	1101	1124	1147	1169	1192	1215	1238	
200	1074	1097	1121	1144	1167	1191	1214	1237	1261	
210	1092	1116	1140	1164	1188	1212	1236	1260	1284	
220	1111	1135	1160	1184	1209	1233	1258	1282	1307	
230	1129	1154	1179	1204	1229	1255	1280	1305	1330	
240	1148	1173	1199	1225	1250	1276	1301	1327	1353	
250	1166	1192	1219	1245	1271	1297	1323	1350	1376	
260	1185	1211	1238	1265	1292	1318	1345	1372	1399	
270	1203	1230	1258	1285	1312	1340	1367	1394	1422	
280	1221	1249	1277	1305	1333	1361	1389	1417	1445	
290	1240	1268	1297	1325	1354	1382	1411	1439	1468	
300	1258	1287	1317	1346	1375	1404	1433	1462	1491	

Höhe cm	Breite									
	270 cm	280 cm	290 cm	300 cm	310 cm	320 cm	330 cm	340 cm	350 cm	
80	1001	1018	1034	1051	1067	1084	1100	1117	1133	
90	1025	1042	1059	1076	1093	1110	1127	1144	1162	
100	1048	1066	1084	1101	1119	1137	1154	1172	1190	
110	1072	1090	1108	1127	1145	1163	1181	1200	1218	
120	1095	1114	1133	1152	1171	1190	1208	1227	1246	
130	1119	1138	1158	1177	1197	1216	1235	1255	1274	
140	1143	1163	1183	1202	1222	1242	1262	1282	1302	
150	1166	1187	1207	1228	1248	1269	1289	1310	1330	
160	1190	1211	1232	1253	1274	1295	1316	1337	1358	
170	1213	1235	1257	1278	1300	1322	1343	1365	1387	
180	1237	1259	1281	1304	1326	1348	1370	1393	1415	
190	1261	1283	1306	1329	1352	1374	1397	1420	1443	
200	1284	1307	1331	1354	1378	1401	1424	1448	1471	
210	1308	1332	1356	1379	1403	1427	1451	1475	1499	
220	1331	1356	1380	1405	1429	1454	1478	1503	1527	
230	1355	1380	1405	1430	1455	1480	1505	1530	1555	
240	1378	1404	1430	1455	1481	1507	1532	1558	1584	
250	1402	1428	1454	1481	1507	1533	1559	1585	1612	
260	1426	1452	1479	1506	1533	1559	1586	1613	1640	
270	1449	1477	1504	1531	1559	1586	1613	1641	1668	
280	1473	1501	1529	1556	1584	1612	1640	1668	1696	
290	1496	1525	1553	1582	1610	1639	1667	1696	1724	
300	1520	1549	1578	1607	1636	1665	1694	1723	1752	

## MEHRPREISE

**manuell:**

Kurbelbedienung innen:

45 €

**Weiteres Zubehör und Steuerungen auf Anfrage!**

**elektrisch:**

24 V

24 V Motor für RWA-Steuerungen:

245 €

Steckernetzteil:

43 €

VP-Netzteil:

78 €

Inis DC-Schalter mit integr. Netzteil:

160 €

230 V

Somfy 230 V Motor:

245 €

Inis Uni UP:

30 €

AP-Rahmen:

12 €

Uno Chronis Easy:

150 €

230 V

Somfy 230 V Funkmotor:

315 €



Telis 1 Pure:

110 €

Telis 2 Pure:

138 €

Chronis RTS Smart:

250 €

